

Motion detector

IS 180-2

black
EAN 4007841 603113
Article number 603113

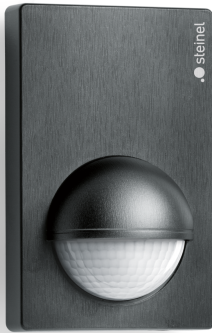

infrared sensor
180°



max. 10 m

1000 W

1000 W max. (LED-
ready)



IP54



2 - 2000 lux



5 sec - 15 min



Ideal 2 m



energy saving

3 years

manufacturer's
warranty



CE

Function description

Homeowner's darling. Infrared wall sensor IS 180-2, for indoors and out, ideal for expansive building fronts and driveways, corner wall bracket for corner mounting available as accessory, 180° angle of coverage, reach can be set up to 12 m or up to 5 m, selectable time and twilight threshold, detection zone can be customised with shrouds.

Technical specifications

Dimensions (L x W x H)	56 x 76 x 120 mm	LED lamps < 2 W	16 W
Manufacturer's Warranty	3 years	LED lamps > 2 W < 8 W	64 W
Settings via	Potentiometers	LED lamps > 8 W	64 W
With remote control	No	Capacitive load in µF	132 µF
Version	black	Technology, sensors	passive infrared, Light sensor
PU1, EAN	4007841603113	Mounting height	1,80 – 4,00 m
Type	Motion detectors	Mounting height max.	4,00 m
Application, place	Indoors, Outdoors	Optimum mounting height	2 m
Application, room	outdoors, front door, all round the building, terrace / balcony, courtyard & driveway	Detection angle	180 °
Colour	black	Angle of aperture	90 °
Colour, RAL	9005	Sneak-by guard	Yes
Includes corner wall mount	No	Capability of masking out individual segments	Yes
Installation site	wall, corner	Electronic scalability	No
Installation	Surface wiring, Wall, corner	Mechanical scalability	No
IP-rating	IP54	Reach, radial	r = 1.5 m (4 m ²) / r = 3 m (14 m ²)
Protection class	II	Reach, tangential	r = 5 m (39 m ²) / r = 12 m (226 m ²)

<https://www.steinel.de>

Subject to technical modifications

10.2023 Page 1 from 3

Motion detector

IS 180-2

black
EAN 4007841 603113
Article number 603113



Technical specifications

Ambient temperature	-20 – 50 °C
Material	Plastic
Mains power supply	230 V / 50 Hz
Switching output 1, resistive	1000 W
Switching output 1, number of LEDs / fluorescent lamps	6 pcs.
Fluorescent lamps, electronic ballast	1000 W
Fluorescent lamps, uncorrected	500 VA
Fluorescent lamps, series-corrected	406 VA
Fluorescent lamps, parallel-corrected	406 VA
Switching output 1, low-voltage halogen lamps	1000 VA

Switching zones	504 switching zones
Twilight setting	2 – 2000 lx
Time setting	5 s – 15 Min.
Basic light level function	No
Main light adjustable	No
Twilight setting TEACH	No
Constant-lighting control	No
Interconnection	Yes
Type of interconnection	Master/master
Interconnection via	Cable

Accessories

EAN 4007841 085148

Corner wall mount for IS 180-2, IS 2180-2 and IS 2180 ECO

Motion detector

IS 180-2

black
EAN 4007841 603113
Article number 603113



Detection Zone

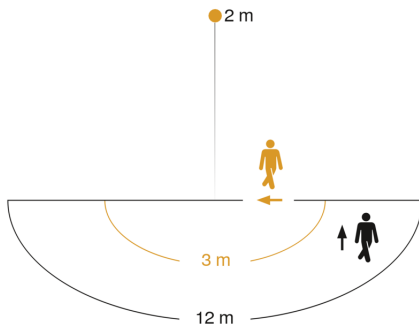

Possible mounting height: 1,80 m– 4,00 m
Orange: radial
Black: tangential

Dimension Drawing

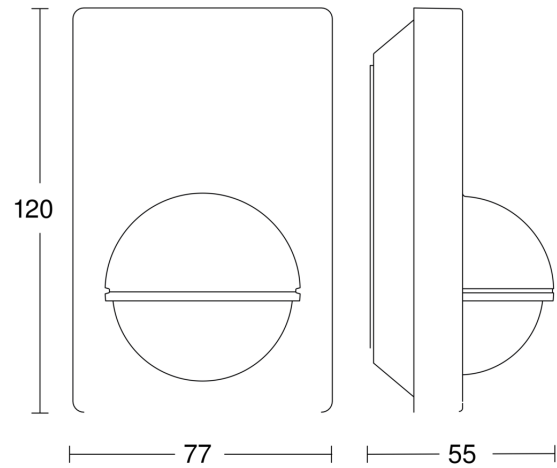

Light without neutral conductor

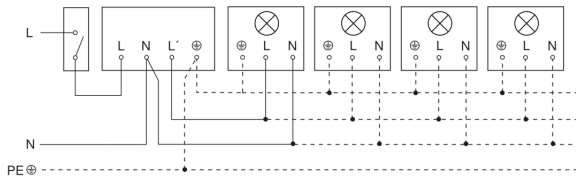

Light with neutral conductor

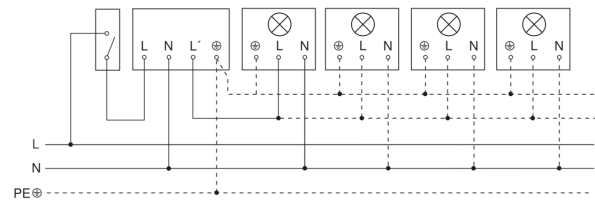

Connection using two-circuit switch for manual and automatic operation



Circuit diagram Connection via a changeover switch for continuous and automatic operation

